

THE PROPERTY OF THE DRAWING IS ESTABLISHED BY LAW. IT IS FORBIDDEN TO PRODUCE OR SHOW IT TO THIRD PART. WITHOUT A WRITTEN AGREEMENT.

Item	Name	Q.ty
1	CA.08.09.011	1
2	CA.08.26.D53.AS	1

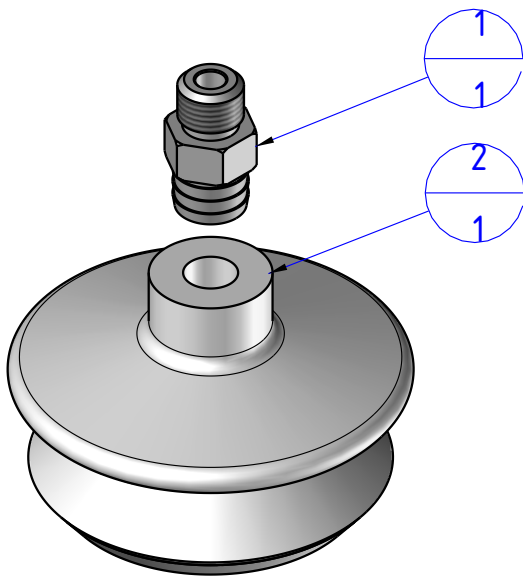
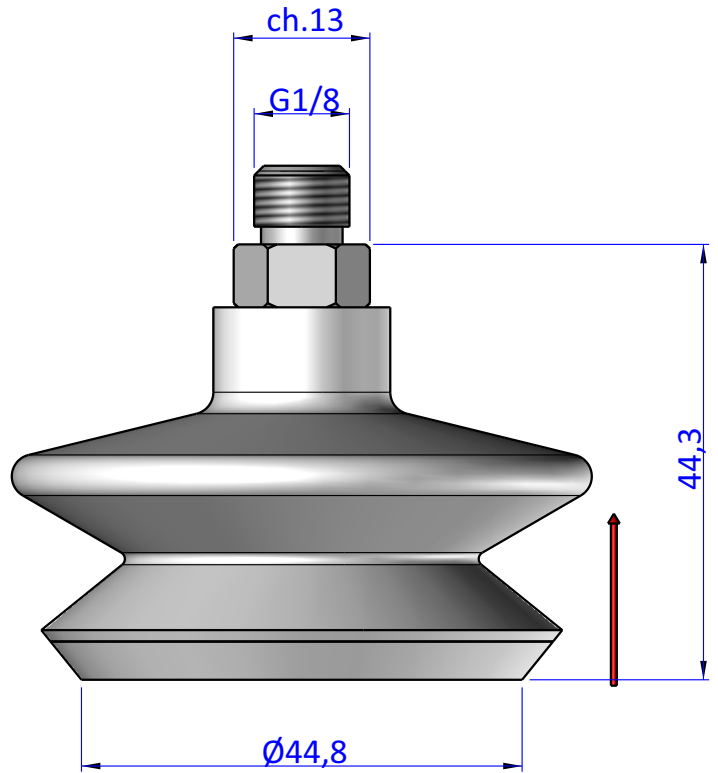

DESIGNED FROM FPS Automation		REVIEW A
DATE 04/11/2020	WEIGHT 0,034kg	
CODE KIT.08.26.D53.11		

Format **A4**

UNI 936-76

GENERAL TOLERANCE

UNI - ISO 2768

CLASSE f

DESCRIPTION

KIT.08.26.D53.11